

Portable Display Systems

Product Catalogue



Appelez-nous!

1 (800) 363-4298

Call Us!





Chapters

RETRACTABLE BANNERS 1

Economy Retractable 3
Value Retractable 5
Performance Retractable 7
Professional Retractable 9
Premium Retractable 15

TENSION DISPLAYS 27

Adjustable Graphic Backdrop 29
X-Banner 31
L-Banner 33
H-Banner 36

EXHIBITION SYSTEMS 37

Vertical Textile Display 39
Textile Backdrop 40
Textile Podium Display 44
Booth Counter Display 44

OUTDOOR DISPLAYS 45

Snap Frame Sidewalk Displays 47
Aluminum A-Board 49
Outdoor Retractable Banner 51
Premium Flag Hardware 52
Street Pole Banners 53

INFORMATION DISPLAYS 55

Surface Mounted Displays 57
Literature Holders 62
Freestanding Displays 63
Signage 71

PARTS & ACCESSORIES 73

Display Lighting Halogen & LED Kits 74
Galaxy™ Tools & Supplies 75
Grip & Grab Instant Grab Adhesive 76
Replacement Parts 77

Interactive Features

NAVIGATE THE CATALOGUE WITH EASE

When viewing the catalogue digitally - whether it be on a desktop or mobile device - know that it is interactive. This smart catalogue includes links to additional product resources such as additional images, graphic templates, installation instructions, and sell sheets.

A Click a product name or page number to navigate to that page.

B Click on the category header to go back to the **chapter** table of contents.

C Click a product name to follow the link to additional product resources.

CHAPTER 1

Retractable Banners

A

- Quarry Series Economy Retractable 3
- Drive Value Retractable 5
- Level Double-Sided Value Retractable 6
- Mineral Performance Retractable 7
- Mineral Pro Performance Retractable 8
- Camber Professional Retractable 9
- Camber Carbon Professional Retractable 10
- Prescott Tabletop Retractable 11
- Axis Desktop Retractable 12
- Strike Series Overview 13
- Strike Premium Retractable 15
- Strike Pro Premium Retractable 17
- Strike Pro XL Premium Retractable 19



Portable Displays Catalogue

Retractable Banners **B**

Quarry **C**

ECONOMY RETRACTABLE BANNER STAND

- Available in a silver finish
- Two twist-out feet for added stability
- Clamp top bar
- Includes carry bag

Item Number	Part Number	Description	Width	Height
ME169700	EE006900	Economy Retractable Banner Stand - Clear	99"	60"

CHAPTER 1

Retractable Banners

Quarry Economy Retractable	3
Drive Value Retractable	5
Level Double-Sided Value Retractable	6
Mineral Performance Retractable	7
Camber Professional Retractable	9
Royale Variable Height Retractable	11
Axis Desktop Retractable	12
Strike Series Guide	13
Strike Premium Retractable	15
Strike Pro Premium Retractable	17
Strike Pro XL Premium Retractable	19
Strike Trace Premium Retractable	21
Strike Trace XL Premium Retractable	22
Strike Duo Double-Sided Premium Retractable	23
Strike Plus Premium Retractable	25
Strike Tabletop Premium Tabletop Retractable	26



The Range

RETRACTABLE BANNER STAND RANGE

GOOD

Economy (left) and **value** (right) retractable banner stands are the most widely used due to their ability to display full-size graphics on a budget. They are lightweight and portable and are well suited for short-term or widespread displays.

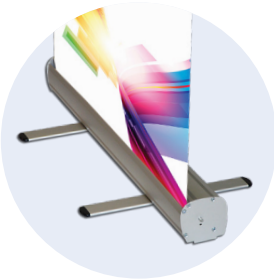

BETTER

Mid-range retractable banner stands - also referred to as **performance** (left) or **professional** (right) - offer upgraded internal components for frequent and extended use. Sturdier and heavier in weight, these stands offer upgraded hardware and aesthetics.

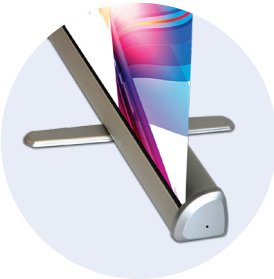

BEST

Premium retractable banner stands offer heavy-duty internal components and a premium appearance finished with chrome-effect end caps. Offered in five heights, six widths, three leader attachment options, three different bags, and either single or double-sided, these banner stands offer an option for every customer.





Quarry

ECONOMY RETRACTABLE BANNER STAND

- Available in a silver finish
- Two twist-out feet for added stability
- Clamp top bar
- Includes carry bag



Part Number	Description	Finish	Width	Height
FE2260SS	QUARRY Economy Retractable Banner Stand	Silver	22"	60"
FE2478SS	QUARRY Economy Retractable Banner Stand	Silver	24"	78¾"
FE3178SS	QUARRY Economy Retractable Banner Stand	Silver	31½"	
FE3378SS	QUARRY Economy Retractable Banner Stand	Silver	33½"	
FE3678SS	QUARRY Economy Retractable Banner Stand	Silver	36"	

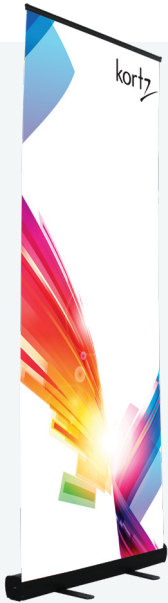

Quarry Carbon

ECONOMY RETRACTABLE BANNER STAND

- Available in a black finish
- Two twist-out feet for added stability
- Clamp top bar
- Includes carry bag

Part Number	Description	Finish	Width	Height
FE3378SSB	QUARRY CARBON Economy Retractable Banner	Black	33½"	78¾"
FE3678SSB	QUARRY CARBON Economy Retractable Banner	Black	36"	



Quarry Tabletop

ECONOMY RETRACTABLE BANNER STAND

- Available in a silver finish
- Two twist-out feet for added stability
- Clamp top bar
- Includes carry bag

Part Number	Description	Finish	Width	Height
FE2228TT	QUARRY TABLETOP Economy Retractable Banner	Silver	22"	28"
FE2436TT	QUARRY TABLETOP Economy Retractable Banner	Silver	24"	36"
FE3648TT	QUARRY TABLETOP Economy Retractable Banner	Silver	36"	48"



Drive

VALUE RETRACTABLE BANNER STAND

- Features reinforced parts to extend lifespan
- Available in a silver finish with black accents
- Two twist-out feet for added stability
- Clamp top bar
- Includes padded carry bag
- 48" and 60" width options come with two poles for added stability



Part Number	Description	Finish	Width	Height
FPR3300SS	DRIVE Value Retractable Banner Stand	Silver	33½"	78¾"
FPR4800SS	DRIVE Value Retractable Banner Stand	Silver	48"	
FPR6000SS	DRIVE Value Retractable Banner Stand	Silver	60"	

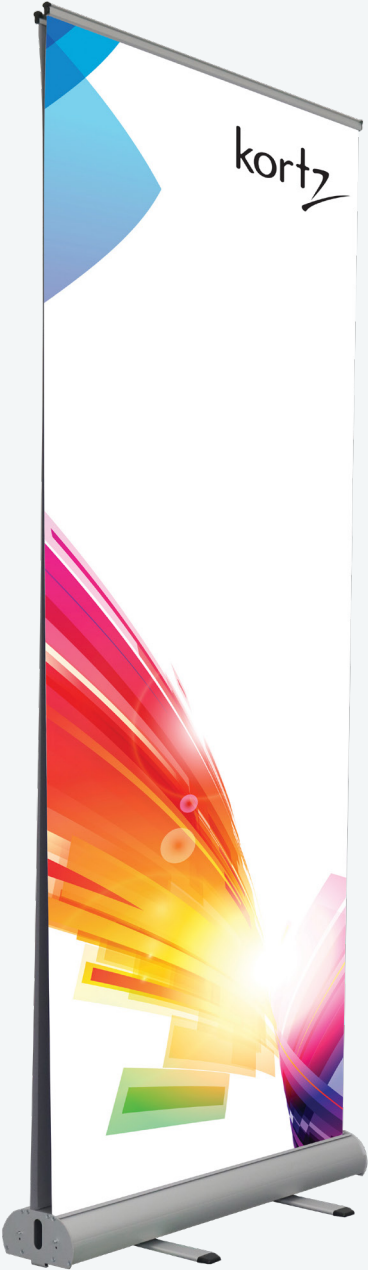

Level

DOUBLE-SIDED VALUE RETRACTABLE BANNER STAND

- Available in a silver finish
- Two twist-out feet for added stability
- Available with a standard pole offering a graphic height of 78¾" tall OR a telescopic pole for a range of visible graphic heights up to 86"
- Clamp top bars
- Includes carry bag



Part Number	Description	Finish	Width	Height
FDRL3378DS	LEVEL Double-Sided Value Retractable Banner	Silver	33½"	78¾"
FDRL3386SST	LEVEL Double-Sided Value Retractable Banner			62-86"

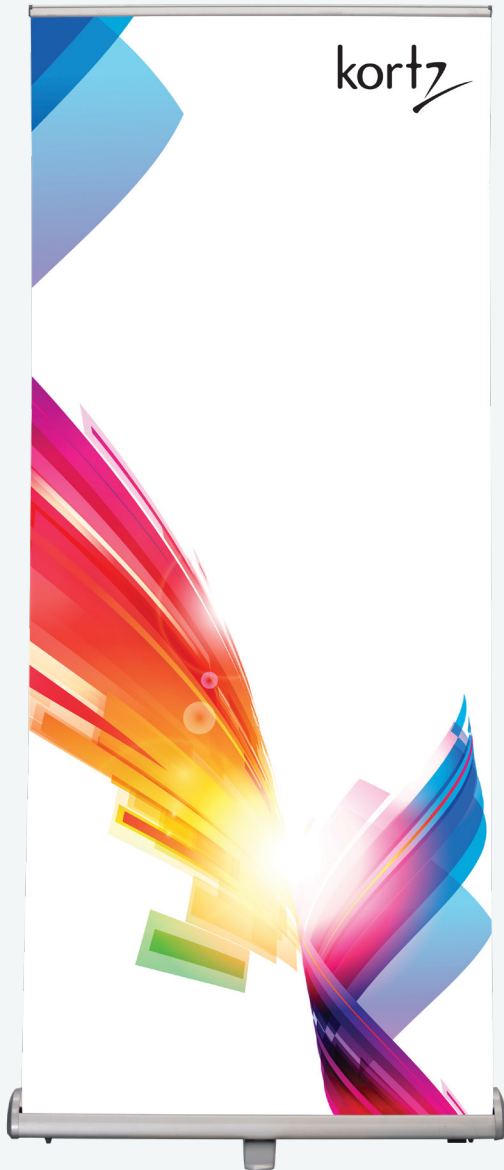

Mineral

PERFORMANCE RETRACTABLE BANNER STAND

- Available in a silver finish
- One twist-out foot for added stability
- Available with a standard pole offering a graphic height of 78¾" tall
- Clamp top bar
- Includes a padded carry bag



Part Number	Description	Finish	Width	Height
FRG3378SS	MINERAL Performance Retractable Banner Stand	Silver	33½"	78¾"
FRG3978SS	MINERAL Performance Retractable Banner Stand	Silver	39⅞"	

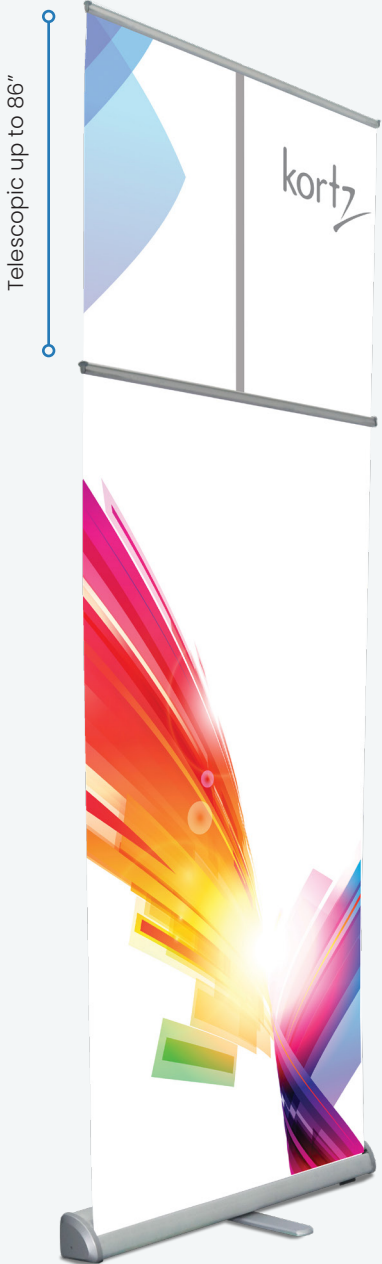

Mineral Pro

PERFORMANCE RETRACTABLE BANNER STAND

- Available in a silver finish
- One twist-out foot for added stability
- Features a telescopic pole for a range of visible graphic heights up to 86" tall
- Clamp top bar
- Includes a padded carry bag

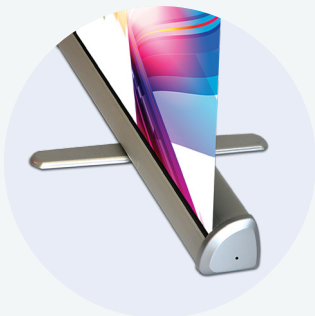

Part Number	Description	Finish	Width	Height
FRGT3386SS	MINERAL PRO Performance Retractable Banner	Silver	33½"	62-86"
FRGT3986SS	MINERAL PRO Performance Retractable Banner	Silver	39⅞"	



Camber

PROFESSIONAL RETRACTABLE BANNER STAND

- Silver finish with black end caps
- Adjustable feet underneath the base for uneven floors
- Features a telescopic pole for a range of visible graphic heights up to 84" tall
- Clamp top bar
- Includes a padded carry bag

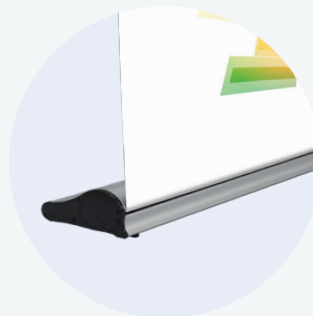

Part Number	Description	Finish	Width	Height
FPFL2400S	CAMBER Professional Retractable Banner Stand	Silver	24"	69-84"
FPFL3100S	CAMBER Professional Retractable Banner Stand	Silver	31½"	62-84"
FPFL3300S	CAMBER Professional Retractable Banner Stand	Silver	33½"	
FPFL3600S	CAMBER Professional Retractable Banner Stand	Silver	36"	
FPFL3900S	CAMBER Professional Retractable Banner Stand	Silver	39¾"	



Camber Carbon

PROFESSIONAL RETRACTABLE BANNER STAND

- Black finish with black end caps
- Adjustable feet underneath the base
- Features a telescopic pole for a range of visible graphic heights up to 84" tall
- Clamp top bar
- Includes a padded carry bag

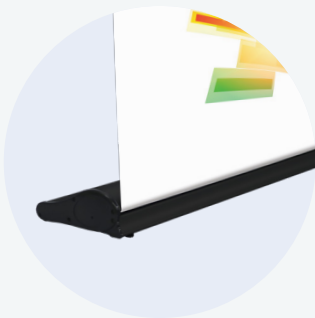
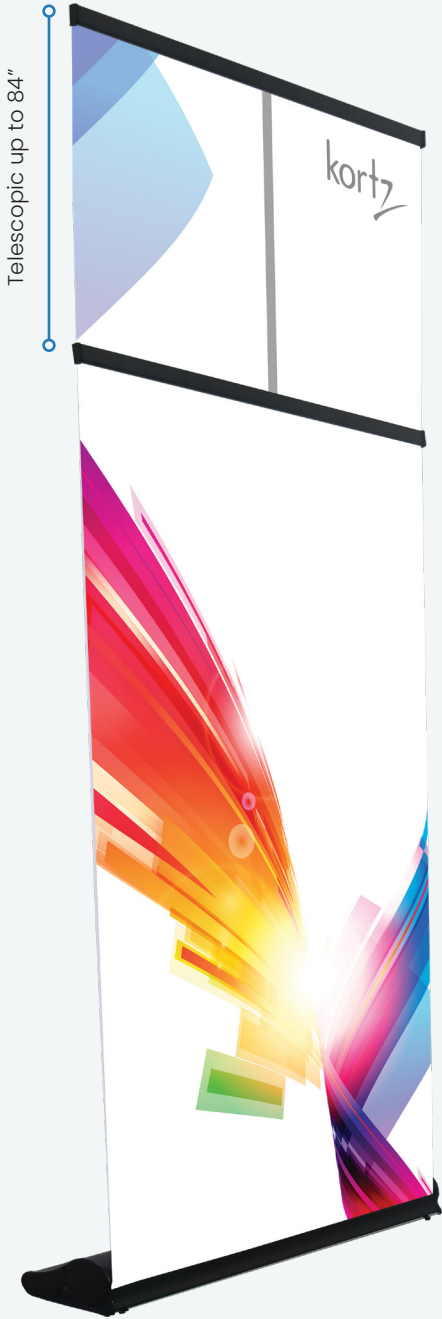

Part Number	Description	Finish	Width	Height
FPFL3300SB	CAMBER CARBON Professional Retractable Banner	Black	33½"	62-84"

Royale

VARIABLE HEIGHT RETRACTABLE BANNER STAND

- Tabletop or floor setup
- Choose between four graphic heights ranging from 15¾" to 63" tall
- Anodized silver finish with dark grey end caps
- Lightweight construction
- Clamp top bar
- Includes carry bag

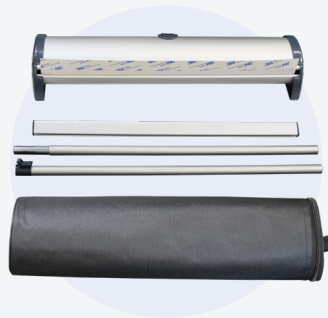

Part Number	Description	Finish	Width	Height
FPRE1531TT	ROYALE Variable Height Retractable Banner	Silver	15¾"	15¾" or 31½"
FPRE1563TT	ROYALE Variable Height Retractable Banner	Silver	15¾"	47¼" or 63"
FPREX2TT	Extension Poles, 2 pcs, use with INE449464			



Axis

DESKTOP RETRACTABLE BANNER STAND

- Silver finish with chrome-effect end plates
- Lightweight aluminum construction
- Adhesive top bar

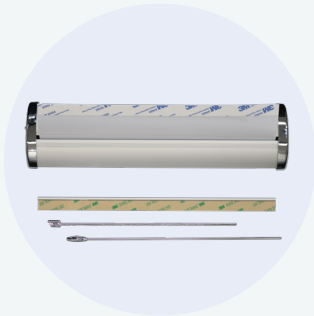
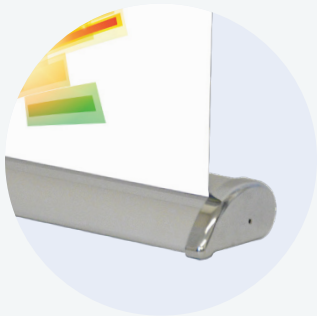

Part Number	Description	Finish	Width	Height
FEM1117TT	AXIS Desktop Retractable Banner Stand	Silver	11"	17"

Strike Series

A GUIDE TO NAVIGATING OUR PREMIUM SERIES

To narrow down the available options, we recommend starting first with desired graphic height. Available graphic heights range from 32" up to 120" tall. Graphic heights are achieved with fixed or telescopic poles.

Secondly, determine the width of the base required. Base widths range from 24" to 60" wide.

Choose between three different base types, and three carry bag variations. Availability varies per product; see individual product pages for more details.





Strike Series

A GUIDE TO NAVIGATING OUR PREMIUM SERIES

	Strike	Pro	Pro XL	Trace	Trace XL	Duo	Plus	Table-top
STEP 1: Choose a Graphic Height								
32-54" Telescopic								✓
78¾" Fixed	✓					✓		
62-86" Telescopic		✓		✓		✓		
82-96" Telescopic			✓		✓			
120" Fixed							✓	
STEP 2: Choose a Graphic Width								
24" Wide	✓	✓	✓			✓		✓
31½" Wide	✓	✓	✓					
33½" Wide	✓	✓	✓	✓	✓	✓	✓	✓
36" Wide	✓	✓	✓			✓		✓
48" Wide	✓	✓	✓			✓		✓
60" Wide	✓	✓	✓					✓
STEP 3: Choose Type of Base								
Standard	✓	✓	✓					
Interchangeable	✓	✓	✓			✓	✓	✓
Clamp				✓	✓			
STEP 4: Choose a Carry Bag								
Padded	✓	✓	✓	✓	✓	✓		✓
Premium	✓	✓	✓	✓	✓	✓		✓
Travel*	✓	✓	✓	✓	✓			✓

NOTES Measurements are in inches. Due to the number of options offered under the Strike Series there are some exceptions to the chart above [ex. Travel* Cases are only available in 31½" and 33½" widths].

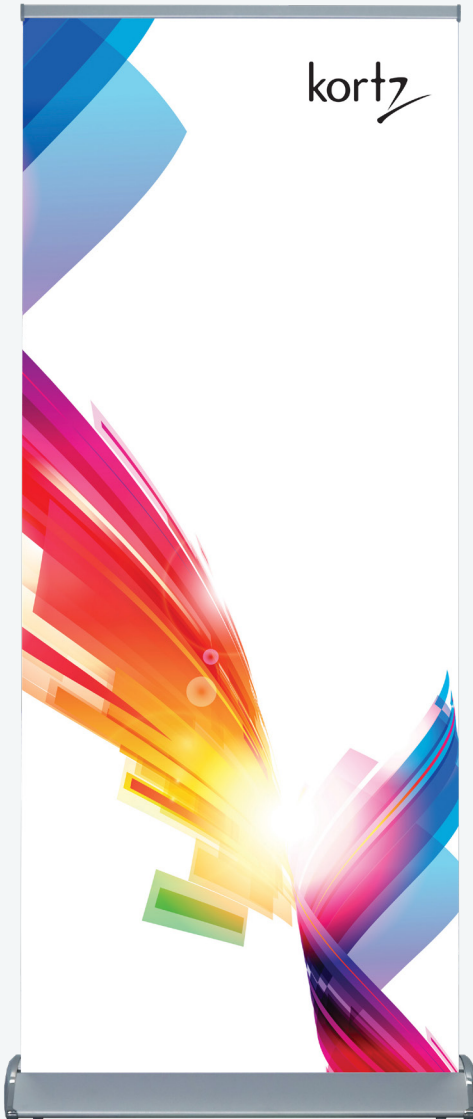

Strike

PREMIUM RETRACTABLE BANNER STAND

- Features a fixed bungee pole for a visible graphic height of 78¾"
- Silver finish with chrome-effect end caps
- Adjustable feet underneath the base
- Clamp top bar
- Choice of three carry bags
- 48" and 60" width options include two poles for maximum stability



padded bag



premium bag



travel case



STANDARD BASE

Features standard tape in method with adhesive tape fastening to the leader.

Part Number	Base Type	Carry Bag	Width	Height
FN2400SS	Standard	Padded	24"	78¾"
FN3100SS	Standard	Padded	31½"	
FN3300SS	Standard	Padded	33½"	
FN3600SS	Standard	Padded	36"	
FN4800SS	Standard	Padded	48"	
FN6000SS	Standard	Padded	60"	
FN2400SSPB	Standard	Premium	24"	78¾"
FN3100SSPB	Standard	Premium	31½"	
FN3300SSPB	Standard	Premium	33½"	
FN3600SSPB	Standard	Premium	36"	
FN4800SSPB	Standard	Premium	48"	
FN6000SSPB	Standard	Premium	60"	
FN3100SSTC	Standard	Travel Case	31½"	78¾"
FN3300SSTC	Standard	Travel Case	33½"	

INTERCHANGEABLE BASE

Feature hook & loop system. Each unit comes with a strip of adhesive loop to apply to the printed banner. The hook comes pre-sewn onto the canvas leader.

Part Number	Base Type	Carry Bag	Width	Height
FNV2400SS	Interchangeable	Padded	24"	78¾"
FNV3300SS	Interchangeable	Padded	33½"	
FNV3600SS	Interchangeable	Padded	36"	
FNV4800SS	Interchangeable	Padded	48"	
FNV6000SS	Interchangeable	Padded	60"	
FNV2400SSPB	Interchangeable	Premium	24"	
FNV3300SSPB	Interchangeable	Premium	33½"	
FNV3600SSPB	Interchangeable	Premium	36"	
FNV4800SSPB	Interchangeable	Premium	48"	
FNV6000SSPB	Interchangeable	Premium	60"	
FNV3300SSTC	Interchangeable	Travel Case	33½"	78¾"

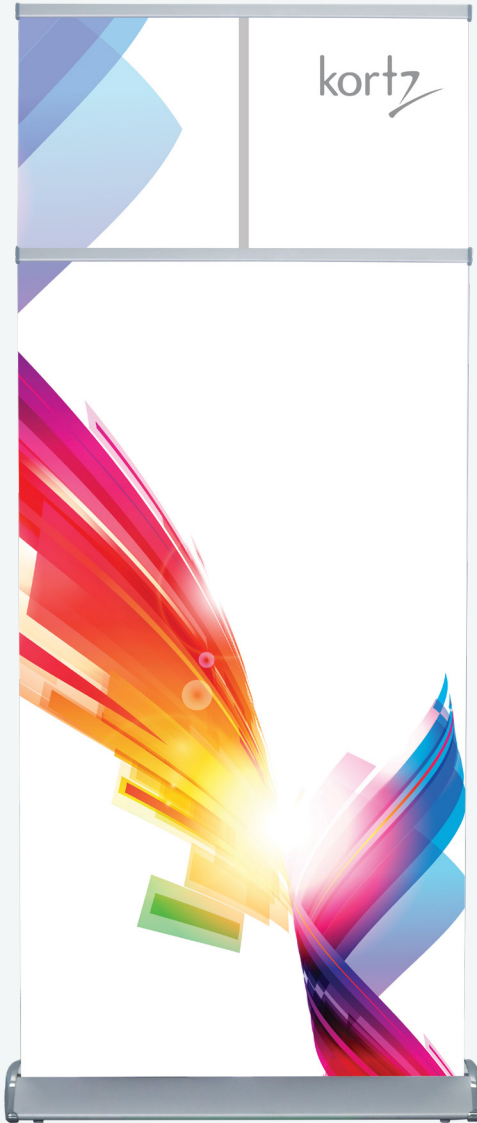

Strike Pro

PREMIUM RETRACTABLE BANNER STAND

- Features a telescopic pole for a range of visible graphic heights up to 86"
- Silver finish with chrome-effect end caps
- Adjustable feet underneath the base
- Clamp top bar
- Choice of three carry bags
- 48" and 60" width options include two poles for maximum stability



padded bag



premium bag



travel case

Retractable Banners

STANDARD BASE

Features standard tape in method with adhesive tape fastening to the leader.

Part Number	Base Type	Carry Bag	Width	Height
FNT2486SS	Standard	Padded	24"	74-86"
FNT3186SS	Standard	Padded	31½"	62-86"
FNT3386SS	Standard	Padded	33½"	
FNT3686SS	Standard	Padded	36"	
FNT4886SS	Standard	Padded	48"	
FNT6086SS	Standard	Padded	60"	
FNT2486SSPB	Standard	Premium	24"	
FNT3186SSPB	Standard	Premium	31½"	62-86"
FNT3386SSPB	Standard	Premium	33½"	
FNT3686SSPB	Standard	Premium	36"	
FNT4886SSPB	Standard	Premium	48"	
FNT6086SSPB	Standard	Premium	60"	
FNT3186SSTC	Standard	Travel Case	31½"	
FNT3386SSTC	Standard	Travel Case	33½"	

INTERCHANGEABLE BASE

Feature hook & loop system. Each unit comes with a strip of adhesive loop to apply to the printed banner. The hook comes pre-sewn onto the canvas leader.

Part Number	Base Type	Carry Bag	Width	Height	
FNVT2486SS	Interchangeable	Padded	24"	74-86"	
FNVT3386SS	Interchangeable	Padded	33½"	62-86"	
FNVT3686SS	Interchangeable	Padded	36"		
FNVT4886SS	Interchangeable	Padded	48"		
FNVT6086SS	Interchangeable	Padded	60"		
FNVT2486SSPB	Interchangeable	Premium	24"		74-86"
FNVT3386SSPB	Interchangeable	Premium	33½"		62-86"
FNVT3686SSPB	Interchangeable	Premium	36"		
FNVT4886SSPB	Interchangeable	Premium	48"		
FNVT6086SSPB	Interchangeable	Premium	60"		
FNVT3386SSTC	Interchangeable	Travel Case	33½"	62-86"	

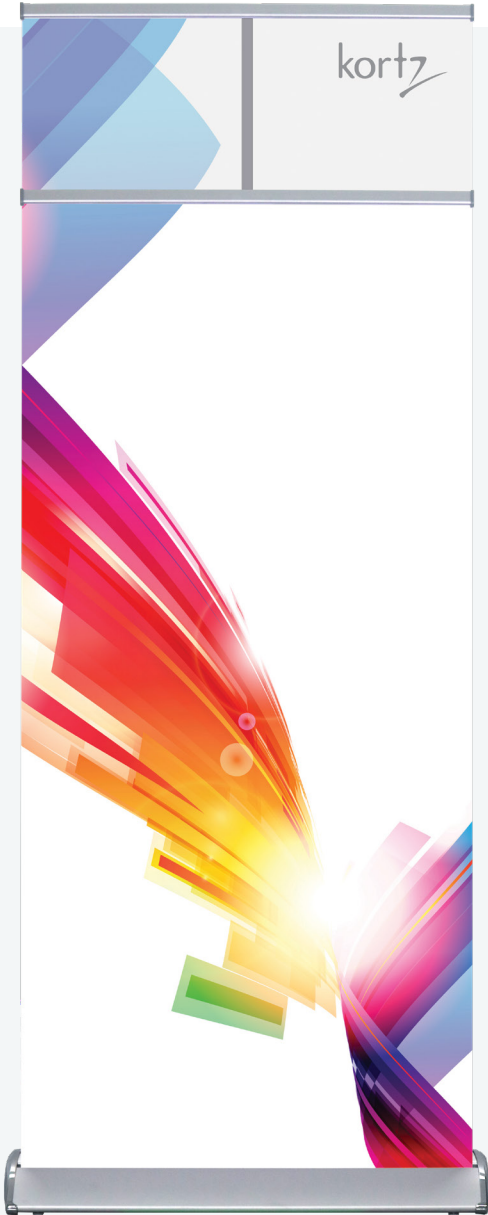

Strike Pro XL

PREMIUM RETRACTABLE BANNER STAND

- **Features a telescopic pole for a range of visible graphic heights up to 96"**
- Silver finish with chrome-effect end caps
- Adjustable feet underneath the base
- Clamp top bar
- Choice of three carry bags
- 48" and 60" width options include two poles for maximum stability



padded bag



premium bag



travel case



STANDARD BASE

Features standard tape in method with adhesive tape fastening to the leader.

Part Number	Base Type	Carry Bag	Width	Height
FNT2496SS	Standard	Padded	24"	86-96"
FNT3196SS	Standard	Padded	31½"	82-96"
FNT3396SS	Standard	Padded	33½"	
FNT3696SS	Standard	Padded	36"	
FNT4896SS	Standard	Padded	48"	
FNT6096SS	Standard	Padded	60"	
FNT2496SSPB	Standard	Premium	24"	
FNT3196SSPB	Standard	Premium	31½"	82-96"
FNT3396SSPB	Standard	Premium	33½"	
FNT3696SSPB	Standard	Premium	36"	
FNT4896SSPB	Standard	Premium	48"	
FNT6096SSPB	Standard	Premium	60"	
FNT3196SSTC	Standard	Travel Case	31½"	
FNT3396SSTC	Standard	Travel Case	33½"	

INTERCHANGEABLE BASE

Feature hook & loop system. Each unit comes with a strip of adhesive loop to apply to the printed banner. The hook comes pre sewn onto the canvas leader.

Part Number	Base Type	Carry Bag	Width	Height	
FNVT2496SS	Interchangeable	Padded	24"	86-96"	
FNVT3396SS	Interchangeable	Padded	33½"	82-96"	
FNVT3696SS	Interchangeable	Padded	36"		
FNVT4896SS	Interchangeable	Padded	48"		
FNVT6096SS	Interchangeable	Padded	60"		
FNVT2496SSPB	Interchangeable	Premium	24"		86-96"
FNVT3396SSPB	Interchangeable	Premium	33½"		82-96"
FNVT3696SSPB	Interchangeable	Premium	36"		
FNVT4896SSPB	Interchangeable	Premium	48"		
FNVT6096SSPB	Interchangeable	Premium	60"		
FNVT3396SSTC	Interchangeable	Travel Case	33½"	82-96"	

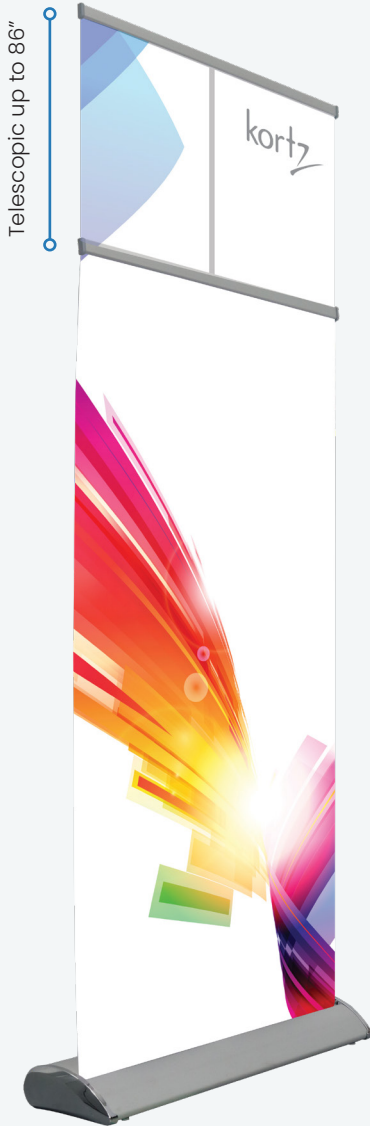

Strike Trace

PREMIUM RETRACTABLE BANNER STAND

- Features a telescopic pole for a range of visible graphic heights up to 86"
- Silver finish with chrome-effect end caps
- Adjustable feet underneath the base
- Clamp top bar
- Choice of three carry bags (see page 19)



CLAMP BASE

Features clamp fastening within base, internal pole storage, and a concealed turn tensioner under the chrome effect end cap.

Part Number	Base Type	Carry Bag	Width	Height
FNCL3386SS	Clamp	Padded	33½"	62-86"
FNCL3386SSPB	Clamp	Premium		
FNCL3386SSTC	Clamp	Travel Case		

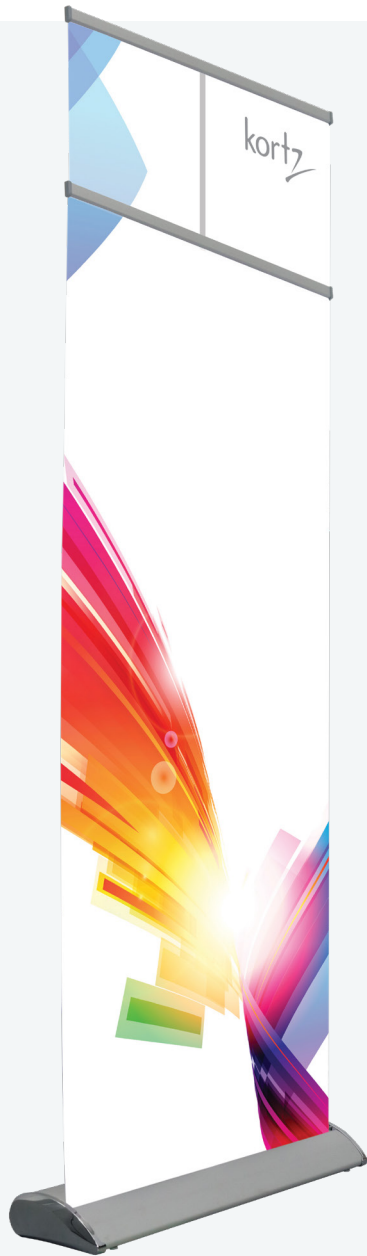

Strike Trace XL

PREMIUM RETRACTABLE BANNER STAND

- Features a telescopic pole for a range of visible graphic heights up to 96"
- Silver finish with chrome-effect end caps
- Adjustable feet underneath the base
- Clamp top bar
- Choice of three carry bags (see page 19)



CLAMP BASE

Features clamp fastening within base, internal pole storage, and a concealed turn tensioner under the chrome effect end cap.

Part Number	Base Type	Carry Bag	Width	Height
FNCL3396SS	Clamp	Padded	33½"	82-96"
FNCL3396SSPB	Clamp	Premium		
FNCL3396SSTC	Clamp	Travel Case		



Strike Duo

PREMIUM DOUBLE-SIDED RETRACTABLE BANNER STAND

- Available with a standard pole offering a graphic height of 78¾" tall OR a telescopic pole for a range of visible graphic heights up to 86"
- Silver finish with chrome-effect end caps
- Adjustable feet underneath the base
- Clamp top bar
- Choice of two carry bags



padded bag



premium bag



Strike Duo

PREMIUM DOUBLE-SIDED RETRACTABLE BANNER STAND

- Standard fixed pole¹ for a total graphic height of 78¾”
- OR telescopic pole² for a range of visible graphic heights up to 86”

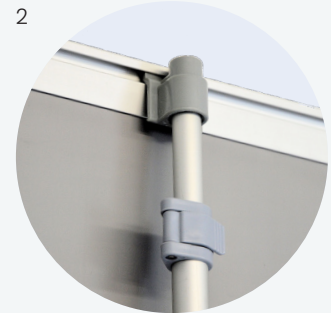

STANDARD BASE

Features standard tape in method with adhesive tape fastening to the leader.

Part Number	Base Type	Carry Bag	Width	Height
FN2400DS	Standard	Padded	24”	78¾”
FN3300DS	Standard	Padded	33½”	
FN3600DS	Standard	Padded	36”	
FN4800DS	Standard	Padded	48”	
FN2400DSPB	Standard	Premium	24”	78¾”
FN3300DSPB	Standard	Premium	33½”	
FN3600DSPB	Standard	Premium	36”	
FN4800DSPB	Standard	Premium	48”	
FN2486DS	Standard	Padded	24”	74-86”
FN3386DS	Standard	Padded	33½”	62-86”
FN3686DS	Standard	Padded	36”	
FN4886DS	Standard	Padded	48”	
FN2486DSPB	Standard	Premium	24”	74-86”
FN3386DSPB	Standard	Premium	33½”	62-86”
FN3686DSPB	Standard	Premium	36”	
FN4886DSPB	Standard	Premium	48”	



Strike Plus

PREMIUM RETRACTABLE BANNER STAND

- Features a fixed 5-part bungee pole for a visible graphic height of 120"
- Silver finish with chrome-effect end caps
- Adjustable feet underneath the base
- Clamp top bar
- Choice of standard or premium carry bag



padded bag



premium bag

INTERCHANGEABLE BASE

Features hook & loop system. Each unit comes with a strip of adhesive loop to apply to the printed banner. The hook comes presewn onto the canvas leader.

Part Number	Base Type	Carry Bag	Width	Height
FNV33120SS	Interchangeable	Padded	33½"	120"
FNV33120SSPB	Interchangeable	Premium		



Strike Tabletop

PREMIUM RETRACTABLE BANNER STAND

- Features a telescopic pole for a range of visible graphic heights up to 54"
- Silver finish with chrome-effect end caps
- Adjustable feet underneath the base
- Clamp top bar and a choice of carry bag

INTERCHANGEABLE BASE

Features hook & loop system. Each unit comes with a strip of adhesive loop to apply to the printed banner. The hook comes pre-sewn onto the canvas leader.

Part Number	Base Type	Carry Bag	Width	Height
FNVT2454TT	Interchangeable	Padded	24"	44-54"
FNVT3354TT	Interchangeable	Padded	33½"	32-54"
FNVT3654TT	Interchangeable	Padded	36"	
FNVT4854TT	Interchangeable	Padded	48"	
FNVT6054TT	Interchangeable	Padded	60"	
FNVT2454TTPB	Interchangeable	Premium	24"	
FNVT3354TTPB	Interchangeable	Premium	33½"	32-54"
FNVT3654TTPB	Interchangeable	Premium	36"	
FNVT4854TTPB	Interchangeable	Premium	48"	
FNVT6054TTPB	Interchangeable	Premium	60"	
FNVT3354TTTC	Interchangeable	Travel Case	33½"	



padded bag



premium bag



travel case

CHAPTER 2

Tension Banners

Alloy Economy Adjustable Backdrop	29
Alloy XL Premium Adjustable Backdrop	30
Vein Economy X-Banner	31
Vein Pro Adjustable X-Banner	32
Fuse Single-Sided L-Banner	33
Fuse Duo Double-Sided L-Banner	34
Flux Tabletop L-Banner	35
Advance Double-Sided H-Banner	36

The Range

TENSION BANNER STAND RANGE

ADJUSTABLE BACKDROP

Telescopic vertical and horizontal supports allow for a variety of graphic sizes. These displays can be quickly assembled and are often used as backdrop solutions.



X-BANNER

Lightweight and inexpensive, these banner stands are easy to use and hold grommeted banners. Popular applications include retail and showroom advertising.



L-BANNER

Clamp bars offer quick banner installation and easy graphic changes. The graphic remains attached to the clamp bars when disassembled and stores together in included carry bag.



ADJUSTABLE H-BANNER

These displays offer a variety of graphic sizes with a telescopic center pole and adjustable bottom clamp fitting. With quick assembly and a small footprint, the potential applications are extensive.



Alloy

ECONOMY ADJUSTABLE GRAPHIC BACKDROP

- Use single or double-sided
- Available in a black finish
- Telescopic poles allow for varying graphic heights and widths
- Banner can be attached to frame with pole pockets OR grommets and banner bungees
- Includes carry bag



DOUBLE SIDED

VARYING WIDTHS AND HEIGHTS
4FT TO 7.5FT



Part Number	Description	Finish	Width	Height
FKS88DS	ALLOY Economy Adjustable Graphic Backdrop	Black	56-90"	42-90"

Alloy XL

PREMIUM ADJUSTABLE GRAPHIC BACKDROP

- Use single or double-sided
- Available in a silver finish
- Telescopic poles allow for varying graphic heights and widths
- Banner can be attached to frame with pole pockets OR grommets and banner bungees
- Includes carry bag



VARYING WIDTHS AND HEIGHTS
5FT TO 10FT

DOUBLE SIDED



Part Number	Description	Finish	Width	Height
FKS1010DS	ALLOY XL Premium Adjustable Graphic Backdrop	Silver	60-120"	60-120"



Vein

ECONOMY X-BANNER

- Quick assembly time; three pieces fit together in mere seconds¹
- Grommeted banner is secured to stand with acorn nuts²
- Rubber, non-slip feet²
- Includes carry bag

1



2



Part Number	Description	Finish	Width	Height
FXB2363F-N	VEIN Economy X-Banner, Small	Black	24"	63"
FXB3172F-N	VEIN Economy X-Banner, Large	Black	31½"	72"

Vein Pro

ADJUSTABLE X-BANNER

- Features telescopic arms and an adjustable hub to accommodate varying graphic heights and widths
- Grommeted banner mounts on four hooks
- Rubber, non-slip feet
- Includes carry bag

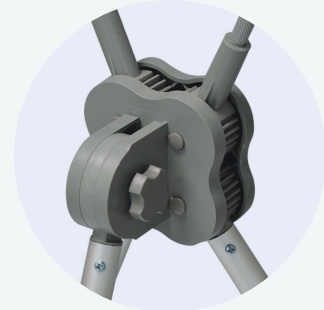

Part Number	Description	Finish	Width	Height
FXBA2436-H	VEIN PRO Adjustable X-Banner	Silver	18-42"	72-86"



Fuse

SINGLE-SIDED ALUMINUM L-BANNER

- Quick assembly time
- Top and bottom clamp bars allow for quick and easy graphic changes
- Small footprint
- Create a multi-banner graphic display by placing several units side-by-side
- Includes rigid carry bag



Part Number	Description	Finish	Width	Height
FR2070SS	FUSE Single-Sided Aluminum L-Banner	Silver	20"	70"
FR2478SS	FUSE Single-Sided Aluminum L-Banner	Silver	24"	78¾"
FR3178SS	FUSE Single-Sided Aluminum L-Banner	Silver	31½"	
FR3378SS	FUSE Single-Sided Aluminum L-Banner	Silver	33½"	
FR3678SS	FUSE Single-Sided Aluminum L-Banner	Silver	36"	

Fuse Duo

DOUBLE-SIDED ALUMINUM L-BANNER

- Quick assembly time
- Top and bottom clamp bars allow for quick and easy graphic changes
- Includes rigid carry bag



Part Number	Description	Finish	Width	Height
FR3178DS	FUSE DUO Double-Sided Aluminum L-Banner	Silver	31½"	79¾"

Flux

TABLETOP ALUMINUM L-BANNER

- Lightweight, tension-based tabletop banner stand
- Quick assembly time
- Adhesive top and bottom rails
- Frameless appearance



Part Number	Description	Finish	Width	Height
FTLB14SS	FLUX Tabletop Aluminum L-Banner	Silver	14¼"	26¾"



Advance

ADJUSTABLE H-BANNER

- Can be used single or double-sided
- Features telescopic center pole and adjustable clamp bar attachment to accommodate varying graphic and overall heights
- Top and bottom clamp bars allow for quick and easy graphic changes
- Small footprint
- Includes carry bag



Part Number	Description	Finish	Width	Height
FAD1884T	ADVANCE Double-Sided Adjustable H-Banner	Silver	18"	36-84"
FAD2484T	ADVANCE Double-Sided Adjustable H-Banner	Silver	24"	36-84"
FAD3184T	ADVANCE Double-Sided Adjustable H-Banner	Silver	31½"	36-84"

CHAPTER 3

Exhibition Systems

Kindle Vertical Textile Display	39
Sustain Curved Textile Backdrop	40
Brace Straight Textile Backdrop	41
Ignite Textile Pop-Up Backdrop	43
Shield Textile Podium Display	44
Crate Booth Counter Display	44

The Range

EXHIBITION SYSTEMS RANGE

FREE-STANDING



Lightweight and sturdy framework with simple assembly, these freestanding displays are perfect for retail and other public spaces. A variety of widths and heights are available for maximum visual impact.

BACKDROP



Both push-fit and pop-up frame options provide great options for applications where a larger graphic display is required. Often used as booth backdrops or step-and-repeat media walls.

PODIUM



Whether it's part of a trade show booth, or a stand-alone kiosk setting, a strong and stable counter is very versatile and can serve many purposes. They are often used along with a backdrop for a complete booth set-up.



Kindle

VERTICAL TEXTILE DISPLAY

- Can be used single or double-sided
- Strong and stable support base
- Lightweight and sturdy framework with push-fit poles for quick & simple assembly
- System dismantles to compact size
- Includes carry bag with light padding

Part Number	Width	Height
FF200TBS	2ft	7½ft
FF204TBS		9½ft
FF208TBS		11½ft
FF212TBS		13½ft
FF300TBS	3ft	7½ft
FF304TBS		9½ft
FF308TBS		11½ft
FF312TBS		13½ft
FF400TBS	4ft	7½ft
FF404TBS		9½ft
FF408TBS		11½ft
FF412TBS		13½ft
FF500TBS	5ft	7½ft
FF504TBS		9½ft
FF508TBS		11½ft
FF512TBS		13½ft

Sustain

CURVED TEXTILE BACKDROP

- Freestanding display that does not require feet due to curved structure
- Lightweight and sturdy framework with push-fit poles for quick and simple assembly¹
- Systems dismantles to compact size
- Choice of standard carry bag or medium wheeled travel case for easy transportation (see page 42)



	Part Number	Description	Carry Bag	Width	Height
	FF435SC	SUSTAIN Curved Textile Backdrop	Standard	8ft	7½ft
	FF437SC	SUSTAIN Curved Textile Backdrop	Standard	10ft	
	FF439SC	SUSTAIN Curved Textile Backdrop	Standard	20ft	
	FF435TC	SUSTAIN Curved Textile Backdrop	Travel	8ft	7½ft
	FF437TC	SUSTAIN Curved Textile Backdrop	Travel	10ft	
	FF439TC	SUSTAIN Curved Textile Backdrop	Travel	20ft	

Brace

STRAIGHT TEXTILE BACKDROP

- Can be used single or double-sided
- Strong and stable support feet¹
- Lightweight and sturdy framework with push-fit poles for quick & simple assembly²
- System dismantles to compact size
- Choice of standard carry bag, or medium wheeled travel case for easy transportation
- Complete the look with the SHIELD textile podium display (pg. 45)

**DOUBLE
SIDED**

**WIDTHS FROM
8FT TO 20FT
+
HEIGHTS FROM
7FT TO 13FT**

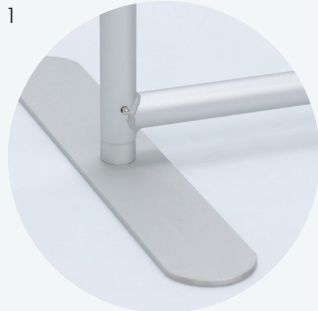



Brace

STRAIGHT TEXTILE BACKDROP

- Choice of standard carry bag, or medium wheeled travel case for easy transportation

STANDARD
Soft fabric with light padding

TRAVEL
Hard plastic with padding



Part Number	Description	Carry Bag	Width	Height
FF442ST	BRACE Straight Textile Backdrop	Standard	8ft	7½ft
FF452ST	BRACE Straight Textile Backdrop	Standard		9½ft
FF462ST	BRACE Straight Textile Backdrop	Standard		11½ft
FF472ST	BRACE Straight Textile Backdrop	Standard		13½ft
FF444ST	BRACE Straight Textile Backdrop	Standard	10ft	7½ft
FF454ST	BRACE Straight Textile Backdrop	Standard		9½ft
FF464ST	BRACE Straight Textile Backdrop	Standard		11½ft
FF474ST	BRACE Straight Textile Backdrop	Standard		13½ft
FF446ST	BRACE Straight Textile Backdrop	Standard	20ft	7½ft
FF456ST	BRACE Straight Textile Backdrop	Standard		9½ft

FF442TC	BRACE Straight Textile Backdrop	Travel	8ft	7½ft
FF452TC	BRACE Straight Textile Backdrop	Travel		9½ft
FF462TC	BRACE Straight Textile Backdrop	Travel		11½ft
FF472TC	BRACE Straight Textile Backdrop	Travel		13½ft
FF444TC	BRACE Straight Textile Backdrop	Travel	10ft	7½ft
FF454TC	BRACE Straight Textile Backdrop	Travel		9½ft
FF464TC	BRACE Straight Textile Backdrop	Travel		11½ft
FF474TC	BRACE Straight Textile Backdrop	Travel		13½ft
FF446TC	BRACE Straight Textile Backdrop	Travel	20ft	7½ft
FF456TC	BRACE Straight Textile Backdrop	Travel		9½ft

Ignite

TEXTILE POP-UP BACKDROP

- Strong and lightweight aluminum frame designed for quick assembly
- Hook fastener is pre-mounted on the frame; a roll of loop fastener is included to sew onto the fabric graphic
- Features the ability to collapse frame with graphic attached
- Choice of standard or rigid travel case for easy transportation



Corner Clip
+ Hook Fastener

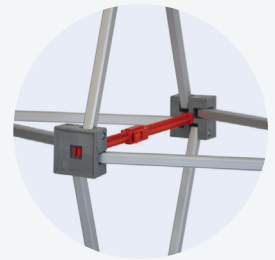

Middle Clip



IGNITE
Collapsed Frame

STANDARD
Carry case

TRAVEL
Carry Case



	Part Number	Description	Carry Bag	Width	Height
	FTFPU33S	IGNITE Textile Pop-Up Backdrop	Standard	7½ft	7½ft
	FTFPU34S	IGNITE Textile Pop-Up Backdrop	Standard	10ft	
	FTFPU33STC	IGNITE Textile Pop-Up Backdrop	Travel	7½ft	7½ft
	FTFPU34STC	IGNITE Textile Pop-Up Backdrop	Travel	10ft	

Shield

TEXTILE PODIUM DISPLAY

- Freestanding portable podium display
- A silicone edge is sewn into the textile graphic; the edge of the graphic is then inserted into a channel at the top and bottom of the frame
- System dismantles to compact size for easy transportation and includes a carry bag



Part Number	Description	Width	Height	Depth
FF461SP	SHIELD Textile Podium Display	31½"	40"	21"

Crate

BOOTH COUNTER DISPLAY

- Adhesive vinyl graphic attaches to the front of the corrugated counter body
- Lightweight and sturdy, holding up to 100lbs
- Quick and easy assembly and disassembly
- Includes carry bags for easy transportation
- Can be used with or without included header and pole kit (Height to top of header is 86")



Part Number	Description	Width	Height	Depth
FBCCUH	CRATE Booth Counter Display	35½"	37"	18¾"

CHAPTER 4

Outdoor Displays

Ore Sidewalk Snap Frame Display.....	47
Ore XL Sidewalk Snap Frame Display.....	47
Emerald Slide-In Style Sidewalk Display	48
Rig Double-Sided A-Board	49
Resin Large A-Frame Banner	50
Carbide Outdoor Retractable Banner Stand	51
Ensign Premium Flag Hardware	52
Terrace Street Pole Hardware	53

The Range

OUTDOOR DISPLAY RANGE

SIDEWALK SIGNAGE



Portable displays allow for communicating with potential customers outdoors. Whether it's menu specials, or event wayfinding, these displays provide an effective medium for the message.

BANNER STANDS

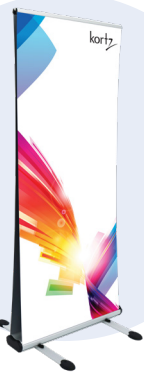

Combining the versatility of indoor retractable banner stands with durable components compatible with the outdoors, these displays offer large visual impact and can be used single or double-sided.

FLAG HARDWARE

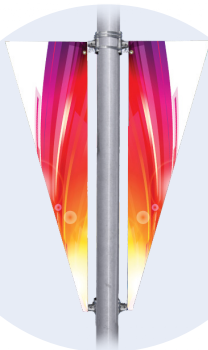

Fiberglass flag pole and street pole hardware provides an effective way to advertise outdoors. Offered in a variety of sizes, these products allow for maximum creativity and are an excellent way to catch attention.

Ore & Ore XL

DOUBLE-SIDED SIDEWALK DISPLAY WITH SNAP FRAMES

- Can be used single or double-sided
- Two separate front-loading snap frames, each with a clear protective graphic cover
- Features heavy duty springs for extended outdoor use
- Base can be filled with water or sand for added stability and incorporates a handle and wheels making transportation easy

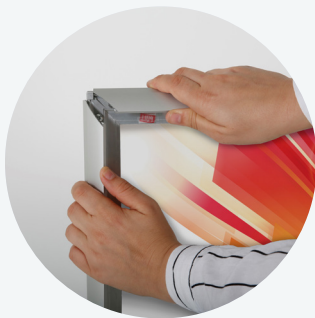

NOTES

For outdoor displays with hollow plastic bases, use additives or sand when using in temperatures below 0°C/32°F.

Part Number	Description	Finish	Width	Height
FCL2436S	ORE Double-Sided Sidewalk Display, 4ft tall	Silver/Grey	24"	36"
FCL2844S	ORE XL Double-Sided Sidewalk Display, 4¼ft tall	Silver/Grey	28"	44"

Emerald

DOUBLE-SIDED SIDEWALK DISPLAY WITH TOP-LOADING CHANNEL

- Can be used single or double-sided
- Features heavy duty springs and for extended outdoor use
- Base can be filled with water or sand for added stability and incorporates a handle and wheels making transportation easy
- Top insert design for easy graphic changes
- Use with standard poster media paired the with supplied poster covers and separator OR use a rigid substrate up to 6mm thick



NOTES

For outdoor displays with hollow plastic bases, use additives or sand when using in temperatures below 0°C/32°F.



Part Number	Description	Finish	Width	Height
FSS2260B	EMERALD Double-Sided Sidewalk Display, 6ft tall	Black	22"	60"

Rig

DOUBLE-SIDED ALUMINUM A-BOARD

- Can be used single or double-sided
- Convenient front-loading snap frames
- Not intended for extended outdoor use
- Features a lightweight design and folds flat for easy transportation
- Includes clear protective graphic covers

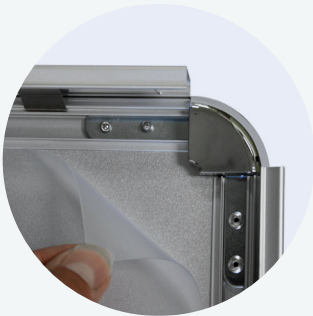

Part Number	Description	Finish	Width	Height
FG2436S	RIG Double-Sided Aluminum A-Board, 4ft tall	Silver	24"	36"

Resin

DOUBLE-SIDED A-FRAME BANNER

- Can be used single or double-sided
- Lightweight, strong aluminum construction
- Easy push-fit assembly
- Includes banner bungees to attach graphic to hardware
- Includes ground pegs to secure hardware to soft ground
- Includes a carry bag



Part Number	Description	Finish	Width	Height
FARHB33XS	RESIN Double-Sided A-Frame Banner, 4ft wide	Silver	44"	33½"
FARHB33S	RESIN Double-Sided A-Frame Banner, 8ft wide	Silver	92½"	
FARHB33SL	RESIN Double-Sided A-Frame Banner, 12ft wide	Silver	141"	

Carbide

DOUBLE-SIDED OUTDOOR RETRACTABLE BANNER STAND

- Can be used single or double-sided
- Two large twist-lock feet for added stability
- Features four stakes included to secure into soft ground
- Heavy-duty base with black end caps
- Spring pole support to absorb wind load
- Includes carry bag



Part Number	Description	Finish	Width	Height
FCDE3378DS	CARBIDE Double-Sided Outdoor Retractable	Silver	33½"	78¼"

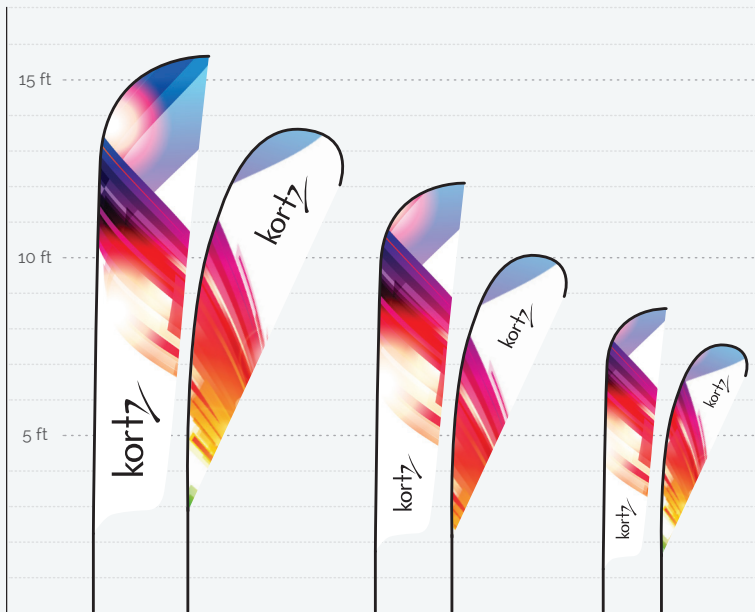

Large
INE816056

Medium
INE816053

Small
INE816050

Ensign

PREMIUM FLAG POLE KITS

- Premium flag poles kits made from fiberglass for durability and longevity
- Each kit accommodates a feather (left) or teardrop (right) shape due to the flexible top section
- Base options sold separately
- Includes carry bag

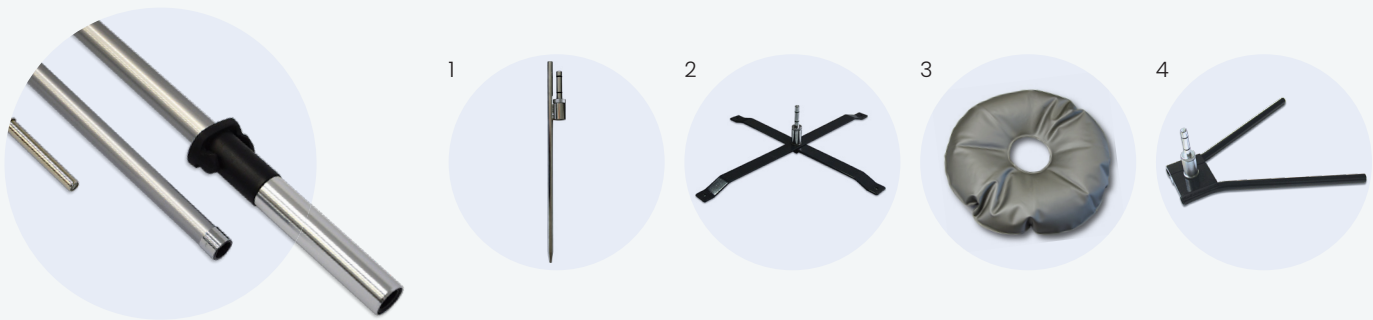

Part Number	Description	Height
FFP7585TF	ENSIGN Flag Pole Kit, Small	Teardrop 7.5' / Feather 8.5'
FFP1012TF	ENSIGN Flag Pole Kit, Medium	Teardrop 10' / Feather 12'
FFP1315TF	ENSIGN Flag Pole Kit, Large	Teardrop 13.5' / Feather 15.5'
FFPSBTF	Spike Base ¹	NOTES These products are designed to withstand wind gusts of no more than 20mph/30kmh. Heavy rain can reduce wind resistance.
FFCBTF	Cross Base ²	
FFWDG	Water Bag ³ (pair with Cross Base)	
FFVBTF	Vehicle Base ⁴	

Terrace

STREET POLE BANNER KITS

- Banner hardware kits suitable for use indoors or outdoors
 - A choice of pole mount, wall mount, and span mount options
 - Heavy duty mounting brackets, D-brackets, and fiberglass poles
- *Components vary based on option #*

Part Number	Width	Description
FSPK18SS	18"	Option #1 Street Pole Kit Single-Sided
FSPK24SS	24"	
FSPK30SS	30"	
FSPK36SS	36"	

Part Number	Width	Description
FSPK18DS	18"	Option #2 Street Pole Kit Double-Sided
FSPK24DS	24"	
FSPK30DS	30"	
FSPK36DS	36"	

Part Number	Width	Description
FSPD18SS	18"	Option #3 D-Bracket Street Pole Kit Single-Sided
FSPD24SS	24"	
FSPD30SS	30"	
FSPD36SS	36"	

Part Number	Width	Description
FSPD18DS	18"	Option #4 D-Bracket Street Pole Kit Double-Sided
FSPD24DS	24"	
FSPD30DS	30"	
FSPD36DS	36"	

Terrace

STREET POLE BANNER KITS

- Pole mount kits include stainless steel bands for secure installation on poles of various sizes
- Wall mount kits do not include mounting fasteners

**Additional bands available (INE814660/FSPSSB)*

Part Number	Width	Description
FWMK18SS	18"	Option #5 Wall Mount Kit Single-Sided
FWMK24SS	24"	
FWMK30SS	30"	
FWMK36SS	36"	

Part Number	Width	Description
FWMD18SS	18"	Option #6 D-Bracket Wall Mount Kit Double-Sided
FWMD24SS	24"	
FWMD30SS	30"	
FWMD36SS	36"	

Part Number	Description
FSMPPD4	Option #7 D-Bracket Span Mount Kit (Pole Application) Single-Sided

Part Number	Description
FSMWWD4	Option #8 D-Bracket Span Mount Kit (Wall Application) Single-Sided

CHAPTER 5

Information Displays & Signage

Ruby Snap Frame	57
Tram II Poster Clamps	58
Fleck Convex Signage	59
Seam Notice Display	60
QuickPro ArtWrap Canvas Wrap System	61
Immerse II Collapsible Literature Holder	62
Milliner Lightweight Literature Holder	62
Repose Freestanding Modular Displays	63
SmartWedge Steel Sign Supports	65
Zenith Sanitizer Station	66
Bearing Metal Sign Display	67
Polar Telescopic Info-Board	68
Pyrite Telescopic Display Easel	69
Vertical Tabletop Display w/ Acrylic Pocket	70
Corian Series Aluminum Sign Standoffs	71
Crystal Series Acrylic Lettermount Studs	72

The Range

RANGE OF INFORMATION DISPLAYS & SIGNAGE

SURFACE MOUNTED



Fastened to the wall or window, surface mounted displays are an ideal way to utilize overlooked surfaces within your establishment to increase awareness of your message or promotion.

FREE-STANDING



Signage that can be placed just about anywhere with available floor space, from aisles to entrance ways. These sturdy, independent displays offer easy-to-change replacement graphics. Get your message seen, switch it up, or move it around with long-lasting freestanding displays.

STANDOFFS

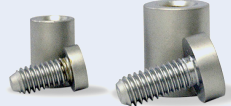

Create beautiful signage installations by using sign standoffs or lettermounts to layer signage and hold it away from the wall.

Ruby

SNAP FRAME

- Front-loading snap frame
- Available in a silver or black finish
- Includes wall fixings and a protective graphic cover
- Made in Turkey

NOTES

Pair the protective graphic covers with vinyl or poster paper. Remove protective graphic covers when using 20pt styrene. Does not accept corrugated plastic sheet.

Units 48" in height will acquire freight overages. They are recommend to be shipped by LTL carriers.



Part Number	Description	Finish	Width	Height
FL8511S	RUBY Aluminum Snap Frame	Silver	8½"	11"
FL1117S	RUBY Aluminum Snap Frame		11"	17"
FL1722S	RUBY Aluminum Snap Frame		17"	22"
FL1824S	RUBY Aluminum Snap Frame		18"	24"
FL2228S	RUBY Aluminum Snap Frame		22"	28"
FL2436S	RUBY Aluminum Snap Frame		24"	36"
FL3648S	RUBY Aluminum Snap Frame		36"	48"
FL8511B	RUBY Aluminum Snap Frame		Black	8½"
FL1117B	RUBY Aluminum Snap Frame	11"		17"
FL2436B	RUBY Aluminum Snap Frame	24"		36"

Tram II

POSTER CLAMPS

- Suitable for wall or window mounting
- Choose between 6 widths ranging from 11" to 60" wide
- Varying graphic heights
- Clamps securely on the top and bottom of the graphic



Part Number	Description	Finish	Width	Length
FPC11S2	TRAM II Aluminum Poster Clamps	Silver	11"	-
FPC22S2	TRAM II Aluminum Poster Clamps		22"	-
FPC24S2	TRAM II Aluminum Poster Clamps		24"	-
FPC36S2	TRAM II Aluminum Poster Clamps		36"	-
FPC48S2	TRAM II Aluminum Poster Clamps		48"	-
FPC60S2	TRAM II Aluminum Poster Clamps		60"	-
FSC2H2	TRAM II Pair of suction cups with hooks			

Fleck

CONVEX WALL/DOOR SIGNAGE

- Includes a clear graphic cover with a key ring suction cup to facilitate interchangeable graphics
- Includes double-sided adhesive tape to fix the unit to wall

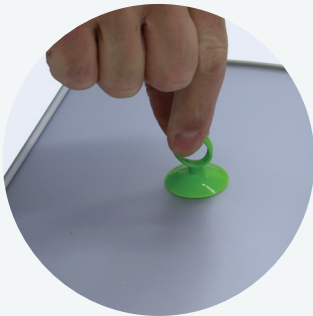

Part Number	Description	Finish	Width	Height
D85L275GP	FLECK Convex Signage, Small	Silver	8½"	2¾"
D85L55GP	FLECK Convex Signage, Medium			5½"
D85L11GP	FLECK Convex Signage, Large			11"



Seam

NOTICE DISPLAY

- Clever design quickly displays posters and notices without the use of tape, magnets or pins
- Comes with foam tape for mounting, and also allows for concealed screw mounting if required
- Wider sizes (up to 5ft in length) easily allow for displaying multiple articles



Push up to insert, pull up to remove.

**WIDTHS
 RANGE FROM
 1FT TO 5FT**

Part Number	Description	Finish	Width
FFND1S	SEAM Notice Display	Silver	13¼"
FFND2S	SEAM Notice Display		24"
FFND4S	SEAM Notice Display		47½"
FFND5S	SEAM Notice Display		60"

QuickPro ArtWrap

CANVAS WRAP SYSTEM

- Premium gallery wrap thickness
- Use in a landscape or portrait orientation
- Product supplied with black back board
- Durable with superior 'no sag' properties
- Quick and easy assembly
- Lightweight, compact, and easy to ship
- US Patent Protected & Global Patents Pending



Quality corners each and every time



Optional back stand*

	Part Number	Description	Dimensions	Quantity
	INE818929	QuickPro ArtWrap Canvas System	8" x 12"	12 pk
	INE818932	QuickPro ArtWrap Canvas System	12" x 12"	12 pk
	INE818938	QuickPro ArtWrap Canvas System	16" x 20"	12 pk
	INE818941	QuickPro ArtWrap Canvas System	20" x 30"	12 pk
	INE818953	Back Stand (for 8" x 12" and 12" x 12")	n/a	12 pk



Immerse II

COLLAPSIBLE LITERATURE HOLDER

- ‘Load and Stow’ collapsible literature holder stores media even when collapsed for added convenience
- Features five single-sided steel 8½”W × 11”H × 1½”D pockets
- Lightweight and easy to use
- Locks in upright and collapsed positions
- Black steel base with ability to add graphics
- Includes padded carry bag



Part Number	Description	Width	Height
FLH956C	Steel Literature Holder (5 Slots)	9"	56¼"

Milliner

LIGHTWEIGHT LITERATURE HOLDER

- A compact way to share printed media
- Available with either 4 or 8 pocket
- Includes carry bag for easy transportation

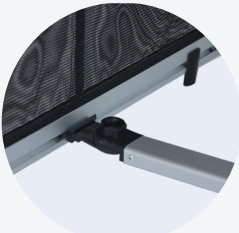

Part Number	Description	Width	Height
FMLH4B	Fabric Literature Holder (4 Pockets)	11"	54"
FMLH8B	Fabric Literature Holder (8 Pockets)	20"	53"

Repose

FREESTANDING MODULAR DISPLAYS

- Freestanding displays consisting of a heavy duty aluminum pole with four mounting channels
- Stable steel base with concealed rubber feet that grip and protect floor surfaces
- Overall height of the stand is 76"
- Aluminum poster frames have an easy to change snap frame¹ profile design and include a clear protective poster cover
- All literature holders and poster frames can be positioned and mounted at any height or side of the pole, and can be repositioned for a different design in minutes²
- Steel literature holders are angled, and offer a large display area of 18"W x 12"H x 1½"D to accept multiple sizes of printed media

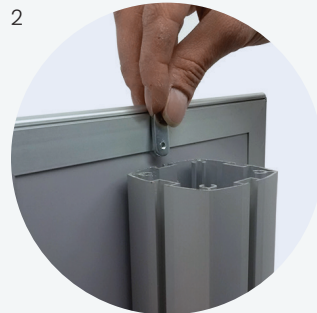



	Part Number	Description	Literature Shelf	22"W x 28"H Frame	24"W x 36"H Frame
	FFDSK1S	Kit 1	-	1	-
	FFDSK2S	Kit 2	-	2	-
	FFDSK3S	Kit 3	-	4	-
	FFDSK4S	Kit 4	1	1	-
	FFDSK5S	Kit 5	2	1	-
	FFDSK6S	Kit 6	2	2	-
	FFDSK7S	Kit 7	4	2	-
	FFDSK8S	Kit 8	-	-	1
	FFDSK9S	Kit 9	-	-	2
	FFDSK10S	Kit 10	1	-	1
	FFDSK11S	Kit 11	2	-	2
	FFDSK12S	Kit 12	3	-	-
	FFDSK13S	Kit 13	6	-	-
	FFDSK14S	Kit 14	4	-	-
	FFDSK15S	Kit 15	8	-	-

SmartWedge



STEEL SIGN SUPPORT

- Use single or double-sided
- Lightweight and strong steel sign support for graphics up to 72" high
- Accepts rigid substrates that support their own weight, up to 1" thick
- Potential for applying branding to sign support surface
- **Manufactured in Canada**

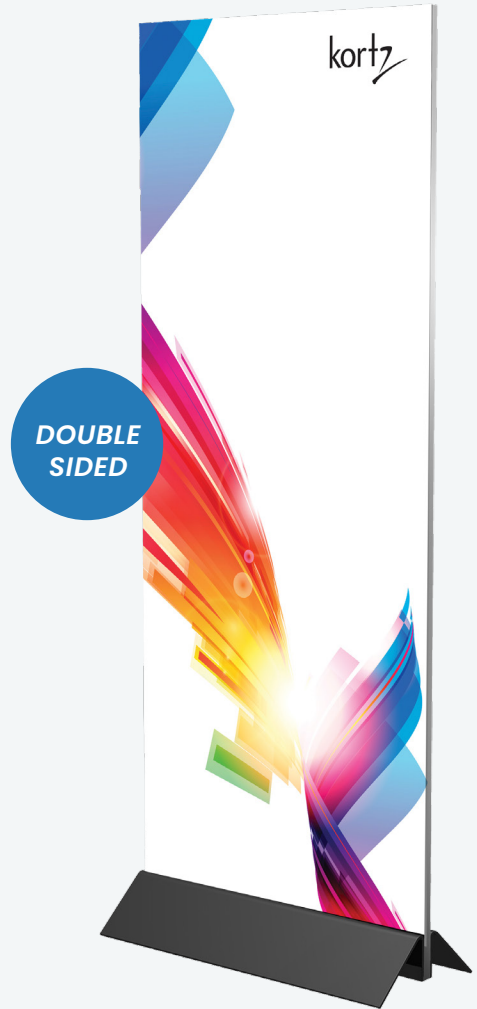
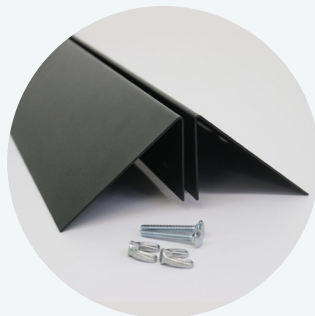
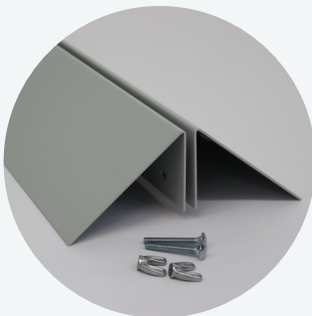

Part Number	Description	Finish	Width	Height
SMARTWEDGE4S	SMARTWEDGE Steel Sign Supports	Silver	4"	up to 72"
SMARTWEDGE24S	SMARTWEDGE Steel Sign Supports		24"	
SMARTWEDGE36S	SMARTWEDGE Steel Sign Supports		36"	
SMARTWEDGE4B	SMARTWEDGE Steel Sign Supports	Black	4"	up to 72"
SMARTWEDGE24B	SMARTWEDGE Steel Sign Supports		24"	
SMARTWEDGE36B	SMARTWEDGE Steel Sign Supports		36"	

Zenith



SANITIZER STATION

- 11" x 17" snap frame display with clear poster cover
- 60" overall height
- Steel base and post for stability in a silver finish
- Light assembly required
- **Manufactured in Canada**



Sanitizer not included

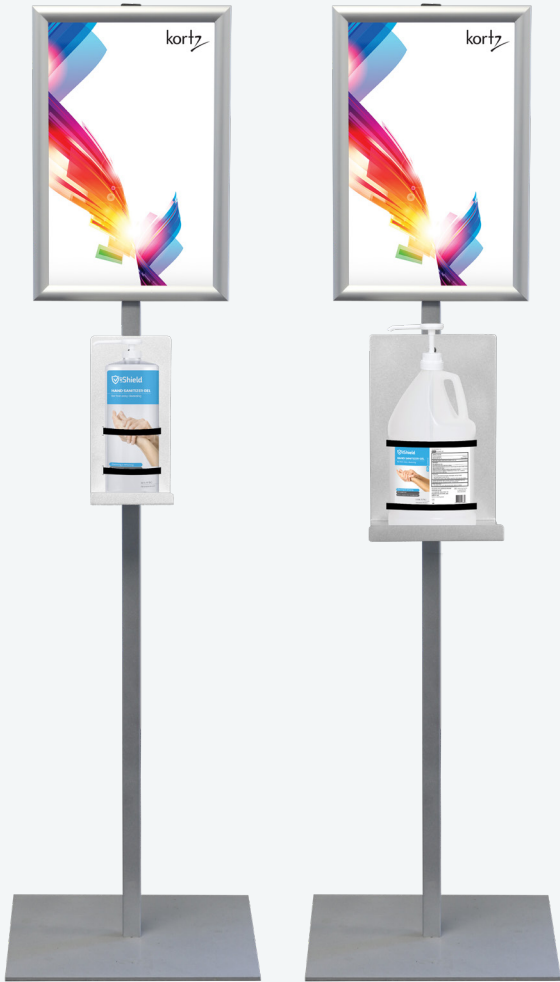

INE448375

INE448444

Part Number	Description
FMHS11171L	Sanitizer Station, w/ shelf for 1 litre sanitizer bottle
FMHS11171G	Sanitizer Station, w/ shelf for 1 gallon sanitizer bottle
FMHSS	Sanitizer Bottle Shelf (10" x 5" x 4¼") with hook & loop straps

Bearing



METAL SIGN DISPLAY

- Use single or double-sided
- Accepts up to 6mm foam core boards
- Top insert design for quick and easy graphic changes
- Overall height of 60"
- **Manufactured in Canada**



Expand the printed graphic to create a header!

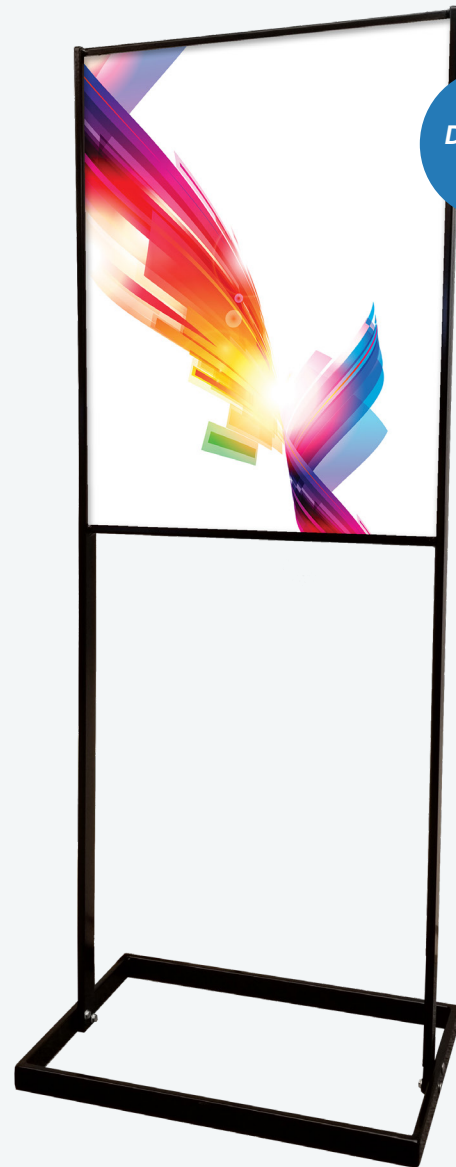

**DOUBLE
SIDED**

Part Number	Description	Finish	Width	Height
FIS2228B	BEARING Double-Sided Metal Sign Display	Black	22"	28"

Polar

TELESCOPIC INFO-BOARD

- Slide-in style frame
- Telescopic pole reaches up to 55"
- Use single or double-sided
- Showcase poster in portrait or landscape orientation
- Anodized aluminum finish
- Easy assembly and disassembly



Slide-in style frame offers quick and easy graphic changes

**DOUBLE
SIDED**



Part Number	Description	Finish	Width	Height
FIBV811S	POLAR Double-Sided Telescopic Info-Board	Silver	8½"	11"

Pyrite

TELESCOPIC DISPLAY EASEL

- Adjustable graphic height as well as adjustable overall height
- Maximum panel height is 32"
- Maximum panel weight is 10lbs
- Rubber, non-slip feet
- Includes carry bag



Part Number	Description	Finish	Width	Height
FDEA32S	PYRITE Telescopic Display Easel	Black	up to 24"	up to 32"

Vertical

TABLETOP DISPLAY W/ ACRYLIC POCKET

- Can be used single or double-sided
- A simple yet effective way to display a printed sheet of paper on a countertop or tabletop
- Aluminum spring-action base holds clear acrylic pocket
- Also available without acrylic poster pocket to display rigid substrates from 1 to 4mm thick in unique shapes and sizes



Get creative and try unique die-cut graphics



Part Number	Description	Finish	Width	Height
FSW8511S	VERTICAL Base & Acrylic Holder	Silver	8½"	11"
FSW85BS	VERTICAL Base Only			-

Corian Series

ALUMINUM SIGN STANDOFFS

- Satin chrome finish
- Create a 3D effect by holding rigid signs away from the wall

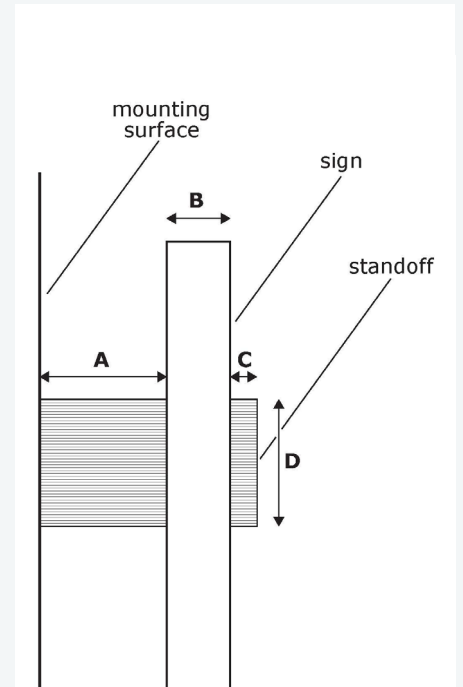
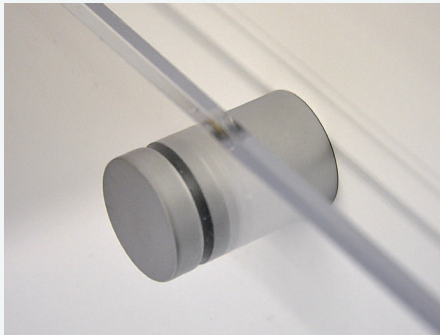

			A	B	C	D	
	Part Number	Description	Barrel Height	Sign Thickness	Cap Height	Diameter	Sign Hole Size
	FL1319H	Standoff	3/4"	up to 3/8"	5/32"	1/2"	3/8"
	FL1925H	Standoff	1"	up to 1/2"	7/32"	3/4"	1/2"
	FL2525HE	Standoff	1"	up to 1/2"	7/32"	1"	1/2"
	FL2525SS	Edge Grip	15/16"	1/4"	3/16"	1"	n/a



Crystal Series

ACRYLIC LETTERMOUNT STUDS

- Hidden sign standoffs for indoor or outdoor signs & lettering applications
- UV stabilized for interior or exterior use
- Acrylic stud features a point, enabling user to create accurate drilling guide
- Perfect for multi-layer signage

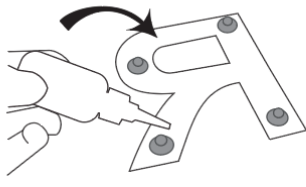

1. Adhere dome portion to the back of the letters

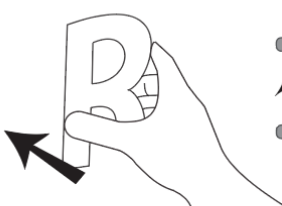

2. Place letter on wall in desired position - the centre spikes will mark positions for cup components

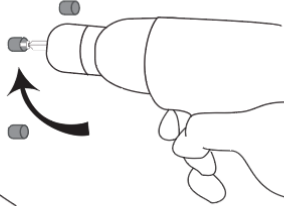

3. Screw the cup portion to the wall

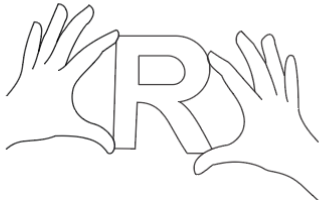

4. Pop the letters into place

Part Number	Description	Size	Quantity
FGLM05	CRYSTAL SERIES Acrylic Lettermount Studs, Medium	1/2"	250 pk
FGLM10	CRYSTAL SERIES Acrylic Lettermount Studs, Large	1"	250 pk

CHAPTER 6

Parts & Accessories

Display Lighting Halogen & LED Kits.....	74
Galaxy Max-Press Grommet Press & Grommets	75
Galaxy Max-Racks Rolling Media Rack	75
Grip & Grab Instant Grab Adhesive	76

Replacement Parts

Additional Loop Fastener	76
Carry Bags	77
Carry Cases	79
Support Poles	80
End-Caps	80

Display Lighting

HALOGEN OR LED LIGHT KITS

- Bring graphics to life with display lighting
- Fully adjustable heads angle and pivot for precise adjustment
- All banner stands 48" wide or wider have two poles so typically require two lights



HALOGEN



LED

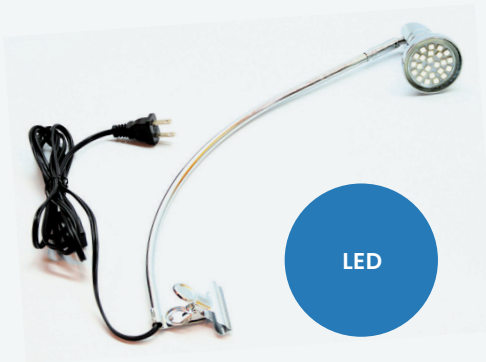

LED

Part Number	Description	Compatibility
FHALTDB	Halogen light	SUSTAIN, BRACE, and KINDLE Textile Displays
FLEDTDB	LED light	SUSTAIN, BRACE, and KINDLE Textile Displays
FHALPUSLB	Halogen light	IGNITE Pop-Up Display
FLEDPUSLB	Halogen light	IGNITE Pop-Up Display
FE3000-RLEDSL	LED light	Any single-sided banner stand

**GALAXY™ MAX-PRESS
GROMMET PRESS & GROMMETS**

- Portable hand-operated grommet press can also be mounted onto work surface
- Easy set-up and quick, single-action operation
- Strong and durable
- Includes #2 die set
- High quality grommets made from solid brass; will not rust



Part Number	Description	Dimensions
FHGP200WDS	Galaxy™ Max-Press Grommet Press	4"W x 10"L x 21"H
FBG2000BR	Galaxy™ Max-Press Grommets, #2 Brass (500pk)	n/a
FBG2000NL	Galaxy™ Max-Press Grommets, #2 Nickel (500pk)	n/a
FBG2000B	Galaxy™ Max-Press Grommets, #2 Black (500pk)	n/a

**GALAXY™ MAX-RACKS
R-SERIES · ROLLING MEDIA RACK**



- Designed to hold 16 media rolls
- Heavy-duty locking castors for ease of control and protection of floor surface
- Holds up to 1000lbs
- **Manufactured in Canada**



Part Number	Description	Dimensions
FMR162WC	Galaxy™ Max-Racks R2, 16 x 2" Core	23"W x 22½"L x 18½"H
FMR163WC	Galaxy™ Max-Racks R2, 16 x 3" Core	24"W x 23½"L x 18½"H

GRIP & GRAB
INSTANT GRAB ADHESIVE

- Out-performs standard grab adhesive by 200%
- Sticks and bonds virtually all substrates
- Bonds and fixes large sign panels and wall boards without support
- Bonds to damp and wet surfaces
- Easily applied with a standard caulking gun
- 290ml – 12 per box



Part Number	Description
INT178150	Grip & Grab Adhesive, 290ml

ADDITIONAL LOOP FASTENER

- For STRIKE Series interchangeable base graphic changes



Part Number	Width	Quantity
INS816160	24"	4 pk
INS816163	33½"	4 pk
INS816166	36"	4 pk
INS816169	48"	4 pk
INS816172	60"	4 pk

Replacement Carry Bags

RETRACTABLE BANNER STAND SERIES + FUSE TENSION DISPLAY



QUARRY



DRIVE



LEVEL



MINERAL



CAMBER



FUSE

	Part Number	Description	Base Width
	FBAE22B	QUARRY, Soft Black Fabric Carry Bag	22"
	FBAE24B	QUARRY, Soft Black Fabric Carry Bag	24"
	FBAE31B	QUARRY, Soft Black Fabric Carry Bag	31½"
	FBAE33B	QUARRY, Soft Black Fabric Carry Bag	33½"
	FBAE36B	QUARRY, Soft Black Fabric Carry Bag	36"
	FBAV33PB	DRIVE, Soft Black Fabric w/ Light Padding	33½"
	FBAV48PB	DRIVE, Soft Black Fabric w/ Light Padding	48"
	FBAV60PB	DRIVE, Soft Black Fabric w/ Light Padding	60"
	FBAV33DSPB	LEVEL, Soft Black Fabric w/ Light Padding	33½"
	FBAM33PB	MINERAL, Soft Black Fabric w/ Light Padding	33½"
	FBAM39PB	MINERAL, Soft Black Fabric w/ Light Padding	39⅝"
	FBAA24PB	CAMBER, Soft Black Fabric w/ Light Padding	24"
	FBAA31PB	CAMBER, Soft Black Fabric w/ Light Padding	31½"
	FBAA33PB	CAMBER, Soft Black Fabric w/ Light Padding	33½"
	FBAA36PB	CAMBER, Soft Black Fabric w/ Light Padding	36"
	FBAA39PB	CAMBER, Soft Black Fabric w/ Light Padding	39⅝"
	FBAFU31B	FUSE, Soft Black Fabric w/ Rigid Tubular Insert	All Widths



PADDED BAG

- Standard bag for STRIKE Series retractable banner stands
- Soft black fabric with light padding

PREMIUM BAG

- Premium bag for STRIKE Series retractable banner stands
- Rigid structure with fabric and internal padding
- Grey colour with black accents

TRAVEL CASE

- Hard shell travel case with foam padding provides a snug fit and maximum protection
- Elastic straps hold product in place
- Locking for security, two keys included
- Adjustable shoulder strap
- Overall exterior size is 6" x 12" x 38"
- For use with STRIKE Series 31½" and 33½" wide stands *excluding the STRIKE DUO. Also fits a LEVEL, or 2pcs of the QUARRY 31½"/QUARRY 33½"/DRIVE 33½"



padded bag



premium bag



travel case

Part Number	Description	Base Width
FBAP24PB	STRIKE Series, Standard Padded Carry Bag	24"
FBAP31PB	STRIKE Series, Standard Padded Carry Bag	31½"
FBAP33SDSPB	STRIKE Series, Standard Padded Carry Bag	33½"
FBAP36PB	STRIKE Series, Standard Padded Carry Bag	36"
FBAP48PB	STRIKE Series, Standard Padded Carry Bag	48"
FBAP60PB	STRIKE Series, Standard Padded Carry Bag	60"
FPB24G	STRIKE Series, Premium Carry Bag	24"
FPB33G	STRIKE Series, Premium Carry Bag	31½" or 33½"
FPB36G	STRIKE Series, Premium Carry Bag	36"
FPB48G	STRIKE Series, Premium Carry Bag	48"
FPB60G	STRIKE Series, Premium Carry Bag	60"
FTCASE	STRIKE Series, Hard Shell Travel Case	31½" or 33½"

CARRY CASES

- Strong plastic wheeled display cases are great for safely transporting a variety of displays, or multiple displays at one time
- Includes soft foam inserts for added protection
- Optional fold-out wooden countertop available for the LVC¹
- Storage area in the underside of the lid for two display lights or other small, fragile items
- Magnet set available for graphic wrap of the LVC (magnet lengths have adhesive for the back of the graphic & magnetize to magnet bars which are built into the surface of the LVC)



LV



LVC

LV COMPATIBILITY

- 3x STRIKE Series 31½"W w/padded bag
- 11x QUARRY Series or DRIVE 33½"W
- 4x LEVEL 33½"W
- 1x SUSTAIN (any size)
- 1x BRACE (any size)

LVC COMPATIBILITY

- 1x SUSTAIN (any size) + 1 SHIELD
- 1x BRACE (any size) + 1 SHIELD
- 2x SHIELDS
- 6x STRIKE Series 24"W w/padded bag
- 3x KINDLE 24"

	Part Number	Description	Dimensions
	FLVTCM	LV, Medium Case	15"D × 16¼"W × 38"H
	FLVCTCL	LVC, Large Case	16"D × 27½"W × 38½"H
	FLVCMS	Magnet Set	
	FWFCTFWHC	Fold-Out Wooden Countertop	



Poles

FIXED¹ & TELESCOPIC² POLE REPLACEMENTS

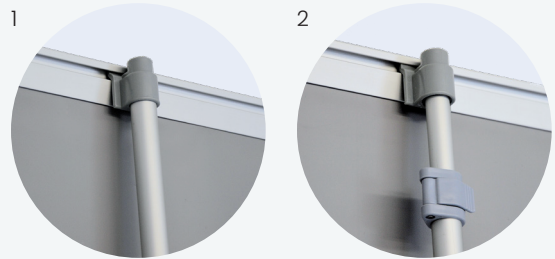

Part Number	Product	Description
FBPAE60SSF	QUARRY	3-part bungee pole 60", silver, 22"
FBPAE78SSF	QUARRY	3-part bungee pole 78¾", silver, 31½", 33½" & 36"
FBPAV78DSF	LEVEL	3-part bungee pole 78¾", silver, double-sided top clip
FBPAP78SSF	STRIKE	3-part bungee pole 78¾", silver, 31½", 33½", 36", 39⅝", 48" & 60"
FBPAP78DSF	STRIKE DUO	3-part bungee pole 78¾", silver, 31½", 33½", 36" & 48"
FTPAP7486T	STRIKE PRO	Telescopic pole 74-86", silver, 24"
FTPAP6286T	STRIKE PRO	Telescopic pole 62-86", silver, 31½", 33½", 36", 39⅝", 48" & 60"
FTPAP8296T	STRIKE PRO XL	Telescopic pole 82-96", silver, 31½", 33½", 36", 48" & 60"
FTPAT4454T	STRIKE TBL	Telescopic pole 44-54", silver, 24"
FTPAT3254T	STRIKE TBL	Telescopic pole 32-54", silver, 33½", 36", 48" & 60"

End Caps

STRIKE SERIES CHROME-EFFECT END CAP REPLACEMENTS

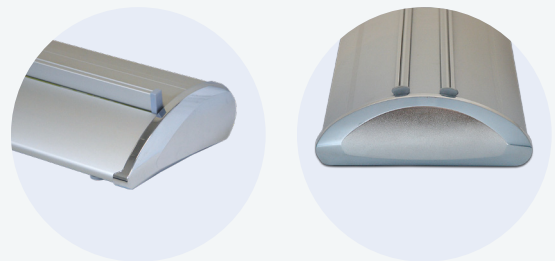

Part Number	Product	Description
FCECALLG	STRIKE	End cap, chrome effect, left side
FCECARRG	STRIKE	End cap, chrome effect, right side
FCECDLRG	STRIKE DUO	End cap, chrome effect, either side

TAS Films, your image specialist!

We offer more than 14,000 products, including printing films, accessories, and equipment for printing shops, laminating centers, and signs as well as wide format. TAS Films is THE destination for all your novelties and printing solutions, whether it's displays or laminating, printing and cutting equipment. We have all the accessories and printing equipment necessary for the smooth running of your business.

For 30 years, the entire TAS Films team has been attentive to your needs and those of your customers, in order to be the image specialist with whom you can be confident for all your printing projects. We understand the challenges of the industry and evolve every day with you.

450.629.7119

1.800.363.4298 (Toll Free)

450.629-2607 (Fax)

1990, blv. Dagenais W., Suite. 100

Laval (QC) H7L 5W2

